

M4x.66xx-x4 - 16 bit 1.25 GS/s Arbitrary Waveform Generator

- **Fast 16 bit arbitrary waveform generator**
- **One, two or four channels**
- **Versions with 1.25 GS/s and 625 MS/s**
- **Output signal bandwidth up to 400 MHz**
- **PXIe 3U format, 2 slots wide**
- **Simultaneous signal generation on all channels**
- **Output level ± 80 mV to ± 2.5 V (± 2.0 V) into 50Ω (± 160 mV to ± 5 V (± 4 V) into high-impedance loads)**
- **Fixed trigger to output delay**
- **Huge 2 GSample on-board memory**
- **FIFO mode continuous streaming output**
- **Modes: Single-Shot, Loop, FIFO, Sequence Replay Mode, Gated, ...**



- PXIe x4 Gen 2 Interface
- Works with all PXIe and PXI hybrid slots
- Sustained streaming mode more than 1.4 GB/s**

Operating Systems	Recommended Software	Drivers
<ul style="list-style-type: none"> • Windows 7 (SP1), 8, 10 • Linux Kernel 2.6, 3.x, 4.x • Windows/Linux 32 and 64 bit 	<ul style="list-style-type: none"> • Visual Basic, Visual C++, C++ Builder, GNU C++, Delphi, VB.NET, C#, J#, Java, Python • SBench 6 	<ul style="list-style-type: none"> • MATLAB • LabVIEW • LabWindows/CVI • IVI

Model	Bandwidth	1 channel	2 channels	4 channels
M4x.6630-x4	400 MHz	1.25 GS/s		
M4x.6631-x4	400 MHz	1.25 GS/s	1.25 GS/s	
M4x.6620-x4	200 MHz	625 MS/s		
M4x.6621-x4	200 MHz	625 MS/s	625 MS/s	
M4x.6622-x4	200 MHz	625 MS/s	625 MS/s	625 MS/s

General Information

The M4x.66xx-x4 series arbitrary waveform digitizers deliver the highest performance in both speed and resolution. The series includes PCIe cards with either one, two or four synchronous channels. The large on-board memory can be segmented to replay different waveform sequences.

The AWGs feature an interface with PCI Express x4 Gen 2 interface that offers outstanding data streaming performance. The interface and Spectrum's optimized drivers enable data transfer rates in excess of 1.4 GB/s so that signals can be continuously replayed at a high output rate.

While the cards have been designed using the latest technology they are still software compatible with the drivers from earlier Spectrum waveform generator cards. So, existing customers can use the same software they developed for a 10 year old 20 MS/s AWG card and for an M4x series 1.25 GS/s AWG.

**Throughput measured with a motherboard chipset supporting a TLP size of 256 bytes.

Software Support

Windows drivers

The cards are delivered with drivers for Windows 7, Windows 8 and Windows 10 (32 bit and 64 bit). Programming examples for Visual C++, C++ Builder, LabWindows/CVI, Delphi, Visual Basic, VB.NET, C#, J#, Python, Java and IVI are included.

Linux Drivers



All cards are delivered with full Linux support. Pre compiled kernel modules are included for the most common distributions like Fedora, Suse, Ubuntu LTS or Debian. The Linux support includes SMP systems, 32 bit and 64 bit systems, versatile programming examples for GNU C++, Python as well as the possibility to get the driver sources for your own compilation.

SBench 6

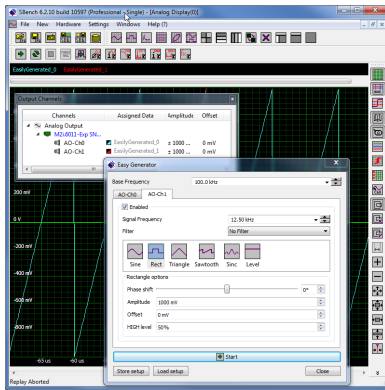

A base license of SBench 6, the easy-to-use graphical operating software for Spectrum cards, is included in the delivery. The base license makes it possible to test the card, generate simple signals or load and replay previously stored SBench 6 signals. It's a valuable tool for checking the cards performance and assisting

with the units initial setup. The cards also come with a demo license for the SBench6 professional version. This license gives the user the opportunity to test the additional features of the professional version with their hardware. The professional version contains several advanced measurement functions, such as FFTs and X/Y display, import and export utilities as well as support for all replay modes including data streaming. Data streaming allows the cards to continuously replay data and transfer it directly from the PC RAM or hard disk. SBench 6 has been optimized to handle data files of several GBytes. SBench 6 runs under Windows as well as Linux (KDE and GNOME) operating systems. A test version of SBench 6 can be downloaded directly over the internet and can run the professional version in a simulation mode without any hardware installed. Existing customers can also request a demo license for the professional version from Spectrum. More details on SBench 6 can be found in the SBench 6 data sheet.

Third-party products

Spectrum supports the most popular third-party software products such as LabVIEW, MATLAB or LabWindows/CVI. All drivers come with detailed documentation and working examples are included in the delivery. Support for other software packages, like VEE or DasyLab, can also be provided on request.

Hardware features and options

PXI Express x4



The M4x series PXI Express cards use a PCI Express x4 Gen 2 connection. They can be used in every PXI Express (PXIe) slot, as well as in any PXI hybrid slot with Gen 1, Gen 2 or Gen 3. The maximum sustained data transfer rate is more than 1.7 GByte/s (read direction) or 1.4 GByte/s (write direction) per slot.

Connections

- The cards are equipped with SMA connectors for the analog signals as well as for the two external trigger inputs, and clock input and output. In addition, there are three MMCX connectors that are used for the three multi-function I/O connectors. These multi-function connectors can be individually programmed to perform different functions:
- Trigger output
- Status output (armed, triggered, ready, ...)
- Synchronous digital inputs, being stored inside the analog data samples
- Asynchronous I/O lines



Singleshot output

When singleshot output is activated the data of the on-board memory is played exactly one time. The trigger source can be either one of the external trigger inputs or the software trigger. After the first trigger additional trigger events will be ignored.

Repeated output

When the repeated output mode is used the data of the on-board memory is played continuously for a programmed number of times or until a stop command is executed. The trigger source can be either one of the external trigger inputs or the software trigger. After the first trigger additional trigger events will be ignored.

Single Restart replay

When this mode is activated the data of the on-board memory will be replayed once after each trigger event. The trigger source can be either the external TTL trigger or software trigger.

FIFO mode

The FIFO mode is designed for continuous data transfer between PC memory or hard disk and the generation board. The control of the data stream is done automatically by the driver on an interrupt request basis. The complete installed on-board memory is used for buffering data, making the continuous streaming extremely reliable.

Multiple Replay

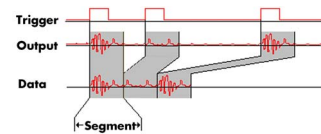

The Multiple Replay mode allows the fast output generation on several trigger events without restarting the hardware. With this option very fast repetition rates can be

achieved. The on-board memory is divided into several segments of the same size. Each segment can contain different data which will then be played with the occurrence of each trigger event.

Gated Replay

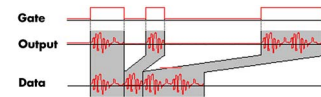

The Gated Sampling mode allows data replay controlled by an external gate signal. Data is only replayed if the gate signal has attained a

programmed level.

Sequence Mode

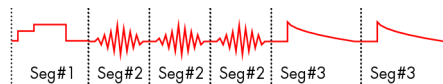

The sequence mode allows to split the card memory into several

data segments of different length. These data segments are chained up in a user chosen order using an additional sequence memory. In this sequence memory the number of loops for each segment can be programmed and trigger conditions can be defined to proceed from segment to segment. Using the sequence mode it is also possible to switch between replay waveforms by a simple soft-

ware command or to redefine waveform data for segments simultaneously while other segments are being replayed.

External trigger input

All boards can be triggered using up to two external analog or digital signals. One external trigger input has two analog comparators that can define an edge or window trigger, a hysteresis trigger or a rearm trigger. The other input has one comparator that can be used for standard edge and level triggers.

External clock input and output

Using a dedicated connector a sampling clock can be fed in from an external system. Additionally it's also possible to output the internally used sampling clock on a separate connector to synchronize external equipment to this clock.

Reference clock

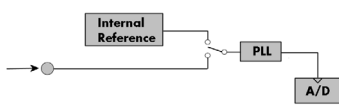

The option to use a precise external reference clock (normally 10 MHz) is necessary to synchronize the instrument for high-quality

measurements with external equipment (like a signal source). It's also possible to enhance the quality of the sampling clock in this way. The driver automatically generates the requested sampling clock from the fed in reference clock.

Technical Data

Analog Outputs

Resolution		16 bit
D/A Interpolation		no interpolation
Output amplitude M4i.663x (1.25 GS/s version)	software programmable	±80 mV up to ±2 V in 1 mV steps into 50 Ω termination (resulting in ±160 mV up to ±4 V in 2mV steps into high impedance loads)
Output amplitude M4i.662x (625 MS/s version)	software programmable	±80 mV up to ±2.5 V in 1 mV steps into 50 Ω termination (resulting in ±160 mV up to ±5 V in 2mV steps into high impedance loads)
Output offset	fixed	0 V
Output Amplifier Path Selection	automatically by driver	Low Power path: ±80 mV to ±480 mV (into 50 Ω) High Power path: ±420 mV to ±2.5 V/±2 V (into 50 Ω)
Output Amplifier Setting Hysteresis	automatically by driver	420 mV to 480 mV (if output is using low power path it will switch to high power path at 480 mV. If output is using high power path it will switch to low power path at 420 mV)
Output amplifier path switching time		10 ms (output disabled while switching)
Filters	software programmable	bypass with no filter or one fixed filter
DAC Differential non linearity (DNL)	DAC only	±0.5 LSB typical
DAC Integral non linearity (INL)	DAC only	±1.0 LSB typical
Output resistance		50 Ω
Minimum output load		0 Ω
Max output swing in 50 Ω		± 2.5 V for 625 MS/s versions or ± 2 V for 1.25 GS/s version
Output accuracy	Low power path High power path	±0.5 mV ±0.1% of programmed output amplitude ±1.0 mV ±0.2% of programmed output amplitude

Trigger

Available trigger modes	software programmable	External, Software, Window, Re-Arm, Or/And, Delay, PXI (M4x only)
Trigger edge	software programmable	Rising edge, falling edge or both edges
Trigger delay	software programmable	0 to (8GSamples - 32) = 8589934560 Samples in steps of 32 samples
Multi, Gate: re-arming time		40 samples
Trigger to Output Delay	sample rate ≤ 625 MS/s sample rate > 1.25 GS/s	238.5 sample clocks + 16 ns 476.5 sample clocks + 16 ns
Memory depth	software programmable	32 up to [installed memory / number of active channels] samples in steps of 32
Multiple Replay segment size	software programmable	16 up to [installed memory / 2 / active channels] samples in steps of 16
Trigger accuracy (all sources)		1 sample
Minimum external trigger pulse width		≥ 2 samples

		Ext0	Ext1
External trigger		50 Ω / 1 kΩ	1 kΩ
External trigger impedance	software programmable	AC or DC	fixed DC
External trigger coupling	software programmable	Window comparator	Single level comparator
External trigger type		±10 V (1 kΩ), ±2.5 V (50 Ω), 2.5% of full scale range	±10 V 2.5% of full scale range = 0.5 V
External input level			
External trigger sensitivity (minimum required signal swing)			
External trigger level	software programmable	±10 V in steps of 1 mV	±10 V in steps of 1 mV
External trigger maximum voltage		±30V	±30 V
External trigger bandwidth DC	50 Ω 1 kΩ	DC to 200 MHz DC to 150 MHz	n.a. DC to 200 MHz
External trigger bandwidth AC	50 Ω	20 kHz to 200 MHz	n.a.
Minimum external trigger pulse width		≥ 2 samples	≥ 2 samples

Clock

Clock Modes	software programmable	internal PLL, external reference clock, Star-Hub sync (M4i only), PXI Reference Clock (M4x only)
Internal clock accuracy		≤ ±20 ppm
Internal clock setup granularity		8 Hz (internal reference clock only, restrictions apply to external reference clock)
Setable Clock speeds		50 MHz to max sampling clock
Clock Setting Gaps		750 to 757 MHz, 1125 to 1145 MHz (no sampling clock possible in these gaps)
External reference clock range	software programmable	≥ 10 MHz and ≤ 1.25 GHz
External reference clock input impedance		50 Ω fixed
External reference clock input coupling		AC coupling
External reference clock input edge		Rising edge
External reference clock input type		Single-ended, sine wave or square wave
External reference clock input swing		0.3 V peak-peak up to 3.0 V peak-peak
External reference clock input max DC voltage		±30 V (with max 3.0 V difference between low and high level)
External reference clock input duty cycle requirement		45% to 55%
External reference clock output type		Single-ended, 3.3V LVPECL
Clock output	sampling clock ≤ 71.68 MHz	Clock output = sampling clock/4
Clock output	sampling clock > 71.68 MHz	Clock output = sampling clock/8
Star-Hub synchronization clock modes	software selectable	Internal clock, external reference clock

Sequence Replay Mode (Mode available starting with firmware V1.14)

Number of sequence steps	software programmable	1 up to 4096 (sequence steps can be overloaded at runtime)
Number of memory segments	software programmable	2 up to 64k (segment data can be overloaded at runtime)
Loop Count	software programmable	1 to (1M - 1) loops
Sequence Step Commands	software programmable	Loop for #Loops, Next, Loop until Trigger, End Sequence
Special Commands	software programmable	Data Overload at runtime, sequence steps overload at runtime, readout current replayed sequence step
Limitations for synchronized products		Software commands changing the sequence are not synchronized between cards. This also applies to multiple AWG modules in a generatorNETBOX.

Multi Purpose I/O lines (front-plate)

Number of multi purpose lines		three, named X0, X1, X2
Input: available signal types	software programmable	Asynchronous Digital-In
Input: impedance		10 kΩ to 3.3 V
Input: maximum voltage level		-0.5 V to +4.0 V
Input: signal levels		3.3 V LVTTTL
Output: available signal types	software programmable	Asynchronous Digital-Out, Synchronous Digital-Out, Trigger Output, Run, Arm, Marker Output, System Clock
Output: impedance		50 Ω
Output: signal levels		3.3 V LVTTTL
Output: type		3.3V LVTTTL, TTL compatible for high impedance loads
Output: drive strength		Capable of driving 50 Ω loads, maximum drive strength ±48 mA
Output: update rate		sampling clock

Bandwidth and Slewrate

	Filter	Output Amplitude	M4i.6630-x8 M4i.6631-x8 DN2.663-xx	M4i.6620-x8 M4i.6621-x8 M4i.6622-x8 DN2.662-xx
Maximum Output Rate			1.25 GS/s	625 MS/s
-3d Bandwidth	no Filter	±480 mV	400 MHz	200 MHz
-3d Bandwidth	no Filter	±1000 mV	320 MHz	200 MHz
-3d Bandwidth	no Filter	±2000 mV	320 MHz	200 MHz
-3d Bandwidth	Filter	all	65 MHz	65 MHz
Slewrate	no Filter	±480 mV	4.5 V/ns	2.25 V/ns

Dynamic Parameters

		M4i.6620-x8 M4i.6621-x8 M4i.6622-x8 DN2.662-xx														
Test - Samplerate	625 MS/s				625 MS/s				625 MS/s							
Output Frequency	10 MHz				50 MHz				50 MHz							
Output Level in 50 Ω	±480 mV		±1000mV		±2500mV		±480 mV		±2500mV		±480 mV		±2500mV			
Used Filter	none								Filter enabled							
NSD (typ)	-150 dBm/Hz	-149 dBm/Hz	-149 dBm/Hz	-150 dBm/Hz	-149 dBm/Hz	-150 dBm/Hz	-149 dBm/Hz	-150 dBm/Hz	-149 dBm/Hz	-150 dBm/Hz	-149 dBm/Hz	-150 dBm/Hz	-149 dBm/Hz			
SNR (typ)	70.7 dB	72.4 dB	63.1 dB	65.3 dB	64.4 dB	67.5 dB	69.4 dB	67.5 dB	69.4 dB	67.5 dB	69.4 dB	67.5 dB	69.4 dB			
THD (typ)	-73.3 dB	-70.5 dB	-49.7 dB	-64.1 dB	-39.1 dB	-68.4 dB	-50.4 dB	-68.4 dB	-50.4 dB	-68.4 dB	-50.4 dB	-68.4 dB	-50.4 dB			
SINAD (typ)	69.0 dB	67.7 dB	49.5 dB	61.6 dB	39.1 dB	64.9 dB	50.3 dB	64.9 dB	50.3 dB	64.9 dB	50.3 dB	64.9 dB	50.3 dB			
SFDR (typ), excl harm.	98 dB	98 dB	99 dB	86 dB	76 dB	88 dB	89 dB	88 dB	89 dB	88 dB	89 dB	88 dB	89 dB			
ENOB (SINAD)	11.2	11.0	8.0	10.0	6.2	10.5	8.1	10.5	8.1	10.5	8.1	10.5	8.1			
ENOB (SNR)	11.5	11.7	10.2	10.5	10.4	10.9	11.2	10.9	11.2	10.9	11.2	10.9	11.2			

		M4i.6630-x8 M4i.6631-x8 DN2.663-xx														
Test - Samplerate	1.25 GS/s				1.25 GS/s				1.25 GS/s							
Output Frequency	10 MHz				50 MHz				50 MHz							
Output Level in 50 Ω	±480 mV		±1000mV		±2000mV		±480 mV		±2000mV		±480 mV		±2000mV			
Used Filter	none								Filter enabled							
NSD (typ)	-150 dBm/Hz	-149 dBm/Hz	-149 dBm/Hz	-150 dBm/Hz	-149 dBm/Hz	-150 dBm/Hz	-149 dBm/Hz	-150 dBm/Hz	-149 dBm/Hz	-150 dBm/Hz	-149 dBm/Hz	-150 dBm/Hz	-149 dBm/Hz			
SNR (typ)	70.5 dB	72.1 dB	71.4 dB	65.2 dB	65.0 dB	67.2 dB	68.2 dB	67.2 dB	68.2 dB	67.2 dB	68.2 dB	67.2 dB	68.2 dB			
THD (typ)	-74.5 dB	-73.5 dB	-59.1 dB	-60.9 dB	-43.9 dB	-67.9 dB	-63.1 dB	-67.9 dB	-63.1 dB	-67.9 dB	-63.1 dB	-67.9 dB	-63.1 dB			
SINAD (typ)	69.3 dB	69.7 dB	59 dB	59.5 dB	43.9 dB	64.5 dB	61.9 dB	64.5 dB	61.9 dB	64.5 dB	61.9 dB	64.5 dB	61.9 dB			
SFDR (typ), excl harm.	96 dB	97 dB	98 dB	85 dB	84 dB	87 dB	87 dB	87 dB	87 dB	87 dB	87 dB	87 dB	87 dB			
ENOB (SINAD)	11.2	11.2	9.5	9.6	6.9	10.4	10.0	10.4	10.0	10.4	10.0	10.4	10.0			
ENOB (SNR)	11.5	11.5	11.5	10.5	10.5	10.9	11.0	10.9	11.0	10.9	11.0	10.9	11.0			

.THD and SFDR are measured at the given output level and 50 Ohm termination with a high resolution M3i.4860/M4i.4450-x8 data acquisition card and are calculated from the spectrum. Noise Spectral Density is measured with built-in calculation from an HP E4401B Spectrum Analyzer. All available D/A channels are activated for the tests. SNR and SFDR figures may differ depending on the quality of the used PC. NSD = Noise Spectral Density, THD = Total Harmonic Distortion, SFDR = Spurious Free Dynamic Range.

SFDR and THD versus signal frequency

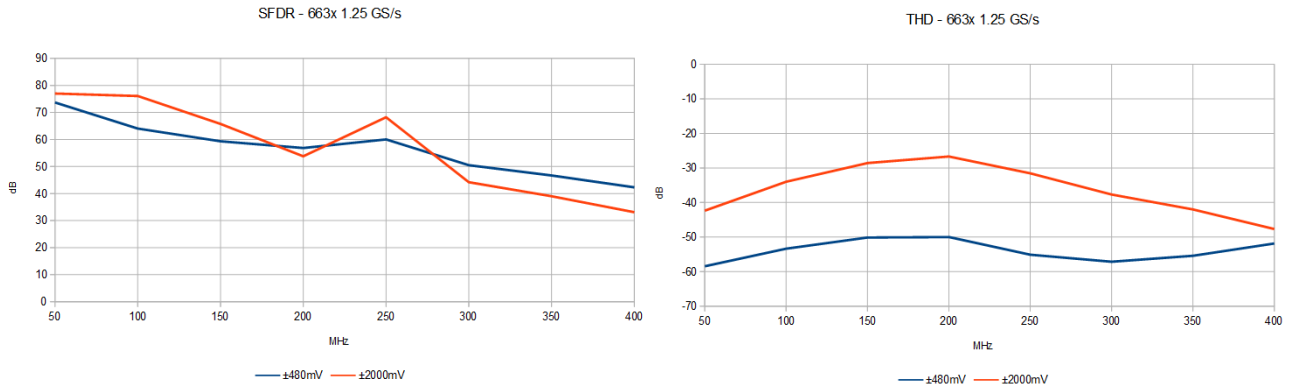

- Measurements done with a spectrum analyzer bandwidth of 1.5 GHz
- Please note that the bandwidth of the high range output is limited to 320 MHz
- Please note that the output bandwidth limit also affects the THD as harmonics higher than the bandwidth are filtered

Connectors

Analog Inputs/Analog Outputs	SMA female (one for each single-ended input)	Cable-Type: Cab-3mA-xx-xx
Trigger 0 Input	SMA female	Cable-Type: Cab-3mA-xx-xx
Clock Input	SMA female	Cable-Type: Cab-3mA-xx-xx
Trigger 1 Input	SMA female	Cable-Type: Cab-3mA-xx-xx
Clock Output	SMA female	Cable-Type: Cab-3mA-xx-xx
Multi Purpose I/O	MMCX female (3 lines)	Cable-Type: Cab-1m-xx-xx

Environmental and Physical Details

Dimension (Single Card)	(PCB only)	160 mm x 100 mm (Standard 3U)
Width		2 slots
Weight (M4x.44xx series)	maximum	340 g
Weight (M4x.22xx, M4x.66xx series)	maximum	450 g
Warm up time		10 minutes
Operating temperature		0°C to 50°C
Storage temperature		-10°C to 70°C
Humidity		10% to 90%

PXI Express specific details

PXIe slot type	4 Lanes, PCIe Gen 2 (x4 Gen2)
PXIe hybrid slot compatibility	Fully compatible
Sustained streaming mode	> 1.7 GB/s (measured with a chipset supporting a TLP size of 256 bytes, using PXIe x4 Gen2)

Certification, Compliance, Warranty

EMC Immunity	Compliant with CE Mark
EMC Emission	Compliant with CE Mark
Product warranty	5 years starting with the day of delivery
Software and firmware updates	Life-time, free of charge

Power Consumption

		PCI EXPRESS		
		3.3V	12 V	Total
M4x.6620-x4	Typical values: All channels activated, Sample rate: 625 MSps	0.25 A	2.5 A	31 W
M4x.6621-x4	Output signal: 31.25 MHz sine wave, Output level: +/- 1 V into 50 Ω load	0.25 A	2.7 A	33 W
M4x.6622-x4		0.25 A	3.0 A	36 W
M4x.6620-x4	Typical values: All channels activated, Sample rate: 625 MSps	0.25 A	2.6 A	32 W
M4x.6621-x4	Output signal: 31.25 MHz sine wave, Output level: +/- 2.5 V into 50 Ω load	0.25 A	2.9 A	35 W
M4x.6622-x4		0.25 A	3.3 A	40 W
M4x.6630-x4	Typical values: All channels activated, Sample rate: 1.25 GSps	0.25 A	2.7 A	33 W
M4x.6631-x4	Output signal: 31.25 MHz sine wave, Output level: +/- 1 V into 50 Ω load	0.25 A	3.0 A	36 W
M4x.6630-x4	Typical values: All channels activated, Sample rate: 1.25 GSps	0.25 A	2.9 A	35 W
M4x.6631-x4	Output signal: 31.25 MHz sine wave, Output level: +/- 2.0 V into 50 Ω load	0.25 A	3.3 A	40 W

MTBF

MTBF	100000 hours
------	--------------

Hardware block diagram

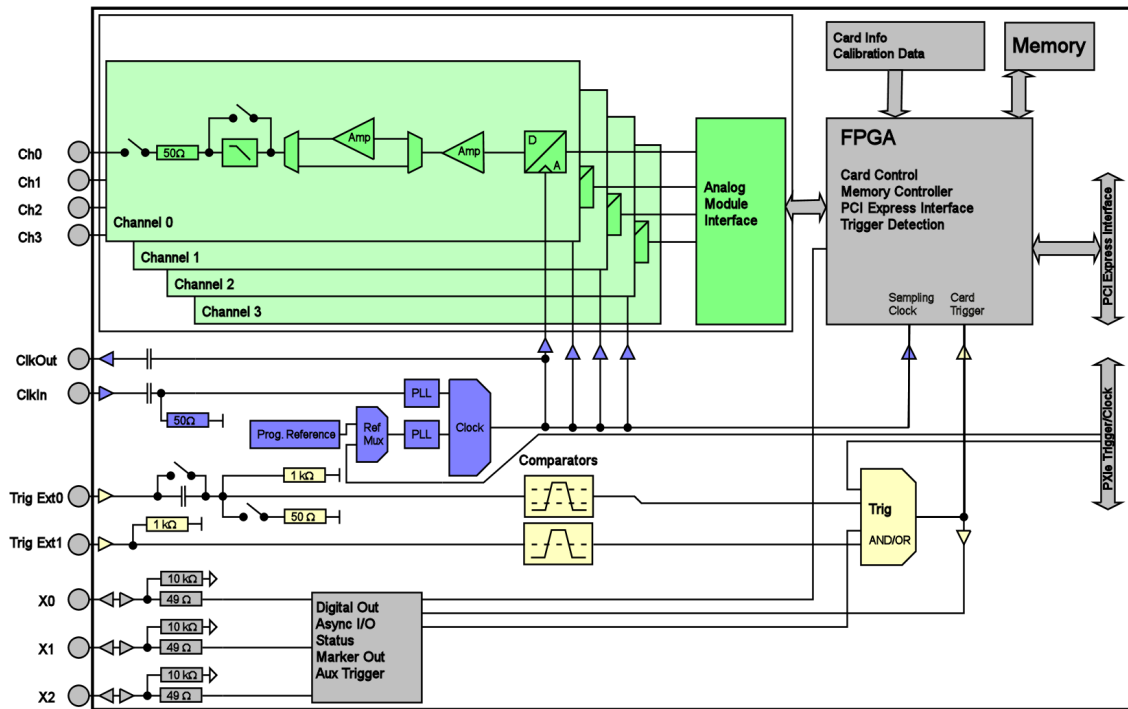

Order Information

The card is delivered with 2 GSample on-board memory and supports standard replay, FIFO replay (streaming), Multiple Replay, Gated Replay, Continuous Replay (Loop), Single-Restart as well as Sequence. Operating system drivers for Windows/Linux 32 bit and 64 bit, examples for C/C++, LabVIEW (Windows), MATLAB (Windows and Linux), LabWindows/CVI, IVI, .NET, Delphi, Visual Basic, Java, Python and a Base license of the measurement software SBench 6 are included.

Adapter cables are not included. Please order separately!

PXI Express x4

Order no.	Bandwidth	Standard mem	1 channel	2 channels	4 channels
M4x.6620-x4	200 MHz	2 GSample	625 MS/s		
M4x.6621-x4	200 MHz	2 GSample	625 MS/s	625 MS/s	
M4x.6622-x4	200 MHz	2 GSample	625 MS/s	625 MS/s	625 MS/s
M4x.6630-x4	400 MHz	2 GSample	1.25 GS/s		
M4x.6631-x4	400 MHz	2 GSample	1.25 GS/s	1.25 GS/s	

Options

Order no.	Option
M4i.663x-hbw	High bandwidth option 600 MHz. Output level limited to ± 480 mV into 50 Ω . Needs external reconstruction filter. One option needed per AWG card.

Services

Order no.	
Recal	Recalibration at Spectrum incl. calibration protocol

Standard Cables

for Connections	Length	Order no.				
		to BNC male	to BNC female	to SMA male	to SMA female	to SMB female
Analog/Clock-In/Trig-In	80 cm	Cab-3mA-9m-80	Cab-3mA-9f-80			
Analog/Clock-In/Trig-In	200 cm	Cab-3mA-9m-200	Cab-3mA-9f-200			
Probes (short)	5 cm		Cab-3mA-9f-5			
Clk-Out/Trig-Out/Extra	80 cm	Cab-1m-9m-80	Cab-1m-9f-80	Cab-1m-3mA-80	Cab-1m-3fA-80	Cab-1m-3f-80
Clk-Out/Trig-Out/Extra	200 cm	Cab-1m-9m-200	Cab-1m-9f200	Cab-1m-3mA-200	Cab-1m-3fA-200	Cab-1m-3f-200
Information	The standard adapter cables are based on RG174 cables and have a nominal attenuation of 0.3 dB/m at 100 MHz and 0.5 dB/m at 250 MHz. For high speed signals we recommend the low loss cables series CHF					

Low Loss Cables

Order No.	Option
CHF-3mA-3mA-200	Low loss cables SMA male to SMA male 200 cm
CHF-3mA-9m-200	Low loss cables SMA male to BNC male 200 cm
Information	The low loss adapter cables are based on MF141 cables and have an attenuation of 0.3 dB/m at 500 MHz and 0.5 dB/m at 1.5 GHz. They are recommended for signal frequencies of 200 MHz and above.

Software SBench6

Order no.	
SBench6	Base version included in delivery. Supports standard mode for one card.
SBench6-Pro	Professional version for one card: FIFO mode, export/import, calculation functions
SBench6-Multi	Option multiple cards: Needs SBench6-Pro. Handles multiple synchronized cards in one system.
Volume Licenses	Please ask Spectrum for details.

Software Options

Order no.	
SPc-RServer	Remote Server Software Package - LAN remote access for M2i/M3i/M4i/M4x/M2p cards
SPc-SCAPP	Spectrum's CUDA Access for Parallel Processing - SDK for direct data transfer between Spectrum card and CUDA GPU. Includes RDMA activation and examples. Signed NDA needed for access.

⁽¹⁾ : Just one of the options can be installed on a card at a time.

⁽²⁾ : Third party product with warranty differing from our export conditions. No volume rebate possible.

Technical changes and printing errors possible

SBench, digitizerNETBOX and generatorNETBOX are registered trademarks of Spectrum Instrumentation GmbH. Microsoft, Visual C++, Visual Basic, Windows, Windows 98, Windows NT, Window 2000, Windows XP, Windows Vista, Windows 7, Windows 8 and Windows 10 are trademarks/registered trademarks of Microsoft Corporation. LabVIEW, DASyLab, Diadem and LabWindows/CVI are trademarks/registered trademarks of National Instruments Corporation. MATLAB is a trademark/registered trademark of The Mathworks, Inc. Delphi and C++Builder are trademarks/registered trademarks of Embarcadero Technologies, Inc. Keysight VEE, VEE Pro and VEE OneLab are trademarks/registered trademarks of Keysight Technologies, Inc. FlexPro is a registered trademark of Weisang GmbH & Co. KG. PCIe, PCI Express and PCI-X and PCI-SIG are trademarks of PCI-SIG. LXI is a registered trademark of the LXI Consortium. PICMG and CompactPCI are trademarks of the PCI Industrial Computer Manufacturers Group. Oracle and Java are registered trademarks of Oracle and/or its affiliates. Intel and Intel Xeon are trademarks or registered trademarks of Intel Corporation. AMD and Opleron are trademarks or registered trademarks of Advanced Micro Devices. NVIDIA, CUDA, GeForce, Quadro and Tesla are trademarks/registered trademarks of NVIDIA Corporation.