

M3i.48xx - 16 bit transient recorder up to 180 MS/s

- Up to 180 MS/s on one or two channels
- Simultaneously sampling on all channels
- Separate monolithic ADC and amplifier per channel
- 6 input ranges: ± 200 mV up to ± 10 V
- Up to 1 GSample (2 GByte) on-board memory
- 256 MSample standard memory installed
- Window, re-arm, OR/AND trigger
- Synchronization of up to 8 cards per system
- Features: Streaming, Multiple Recording, Timestamps

Speed	SNR	ENOB
65 MS/s	up to 75.4 dB	up to 12.2 LSB
105 MS/s	up to 74.7 dB	up to 12.1 LSB
180 MS/s	up to 73.4 dB	up to 11.9 LSB



PCI / PCI-X

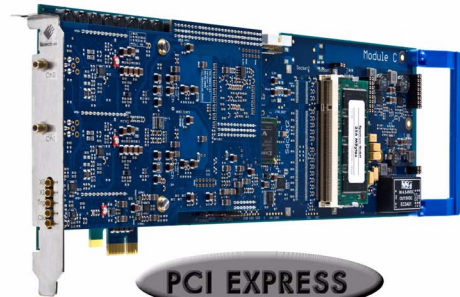

PCI EXPRESS

- | | |
|---|--|
| <ul style="list-style-type: none"> • 66 MHz 32 bit PCI-X interface • 5V / 3.3V PCI compatible • 100% compatible to conventional PCI > V2.1 • Sustained streaming mode up to 245 MB/s | <ul style="list-style-type: none"> • 2,5 GBit x1 PCIe Interface • Works with x1/x4/x8/x16* PCIe slots • Software compatible to PCI • Sustained streaming mode up to 160 MB/s |
|---|--|

Operating Systems	Recommended Software	Drivers
<ul style="list-style-type: none"> • Windows XP, Vista, 7, 8, 10 • Linux Kernel 2.4, 2.6, 3.x, 4.x • Windows/Linux 32 and 64 bit 	<ul style="list-style-type: none"> • Visual Basic, Visual C++, Borland Delphi + C++ Builder, GNU C++, VB.NET, C#, J#, Java, Python • SBench 6 	<ul style="list-style-type: none"> • MATLAB • LabVIEW • LabWindows/CVI

Model	1 channel	2 channels
M3i.4830	65 MS/s	
M3i.4831	65 MS/s	65 MS/s
M3i.4840	105 MS/s	
M3i.4841	105 MS/s	105 MS/s
M3i.4860	180 MS/s	
M3i.4861	180 MS/s	180 MS/s

General Information

The 6 models of the M3i.48xx series are designed for the fast and high quality data acquisition. Each of the input channels has its own monolithic A/D converter and its own programmable input amplifier. This allows to record signals simultaneously on both channels with 16 bit resolution without any phase delay between them. The extremely large on-board memory allows long time recording even with the highest sampling rates. All boards of the M3i.48xx series may use the whole installed on-board memory for the currently activated number of channels. A FIFO mode is also integrated on the board. This allows the acquisition of data continuously for online processing or for data storage to hard disk.

*Some x16 PCIe slots are for the use of graphic cards only and can not be used for other cards.

Software Support

Windows drivers

The cards are delivered with drivers for Windows XP and Vista (32 bit), as well as Windows 7, Windows 8 and Windows 10 (32 bit and 64 bit). Programming examples for Visual C++, Borland C++ Builder, LabWindows/CVI, Borland Delphi, Visual Basic, VB.NET, C#, J#, Python, Java and IVI are included.

Linux Drivers



All cards are delivered with full Linux support. Pre-compiled kernel modules are included for the most common distributions like RedHat, Fedora, Suse, Ubuntu LTS or Debian. The Linux support includes SMP systems, 32 bit and 64 bit systems, versatile programming examples for Gnu C++, Python as well as the possibility to get the driver sources for your own compilation.

SBench 6

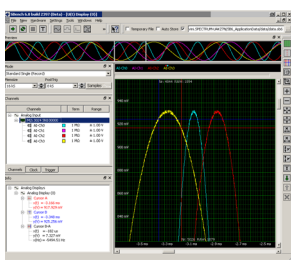

A base license of SBench 6, the easy-to-use graphical operating software for Spectrum cards, is included in the delivery. The base license makes it possible to test the card, display acquired data and make some basic measurements. It's a valuable tool for checking the card's performance and assisting with the unit's initial setup. The cards also come with a demo license for the SBench 6 professional version. This license gives the user the opportunity to test the additional features of the professional version with their hardware. The professional version contains several advanced measurement functions, such as FFTs and X/Y display, import and export utilities as well as support for all acquisition modes including data streaming. Data streaming allows the cards to continuously acquire data and transfer it directly to the PC RAM or hard disk. SBench 6 has been optimized to handle data files of several GBytes. SBench 6 runs under Windows as well as Linux (KDE, GNOME and Unity) operating systems. A test version of SBench 6 can be downloaded directly over the internet and can run the professional version in a simulation mode without any hardware installed. Existing customers can also request a demo license for the professional version from Spectrum. More details on SBench 6 can be found in the SBench 6 data sheet.

Third-party Software Products

Most popular third-party software products, such as LabVIEW, MATLAB or LabWindows/CVI are supported. All drivers come with examples and detailed documentation.

Hardware features and options

PCI/PCI-X



X or PCI 64 slots. The maximum sustained data transfer rate is 245 MByte/s per bus segment.

The cards with PCI/PCI-X bus connector use 32 Bit and up to 66 MHz clock rate for data transfer. They are 100% compatible to Conventional PCI > V2.1. The universal interface allows the use in PCI slots with 5 V I/O and 3.3 V I/O voltages as well as in PCI-

PCI Express



160 MByte/s per slot.

The cards with PCI Express use a x1 PCIe connector. They can be used in PCI Express x1/x4/x8/x16 slots, except special graphic card slots, and are 100% software compatible to Conventional PCI > V2.1. The maximum sustained data transfer rate is

SMA connectors



Out.

As an alternative to the standard SMB and MMCX connections the card can also be equipped with SMA connectors. The SMA connections are available for the analog input signals (option -SMAM) or for the analog inputs as well as for two of the additional connections (option -SMA). These connections must be defined on the purchase order of the -SMA option and can be a selection of: Trig-In, Trig-Out, Multi-Purpose X0, Clk-In, Clk-

Input Amplifier

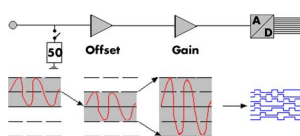

The analog inputs can be adapted to real world signals using a wide variety of settings that are individual for each channel. By using software commands the input termination can be changed between 50 Ohm and 1 MOhm, one can select a matching input range and the signal offset can be compensated by programmable AC coupling.

Software selectable input path

For each of the analog channels the user has the choice between two analog input paths. The „Buffered“ path offers the highest flexibility when it comes to input ranges and termination. A software programmable 50 Ohm and 1 MOhm termination also allows to connect standard oscilloscope probes to the card. The „50 Ohm“ path on the other hand provides the highest bandwidth and the best signal integrity with a fewer number of input ranges and a fixed 50 Ohm termination.

Software selectable lowpass filter

Each analog channel contains a software selectable low-pass filter to limit the input bandwidth. Reducing the analog input bandwidth results in a lower total noise and can be useful especially with low voltage input signals.

Automatic on-board calibration

Every channel of each card is calibrated in the factory before the board is shipped. However, to compensate for environmental variations like PC power supply, temperature and aging the software driver includes routines for automatic offset and gain calibration. This calibration is performed on all input ranges of the "Buffered" path and uses a high precision onboard calibration reference.

Digital inputs

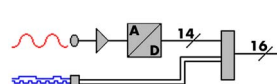

This option acquires additional synchronous digital channels phase-stable with the analog data. A maximum of 2 additional digital inputs are available on the front plate of the card using the multi-purpose I/O lines.

Ring buffer mode

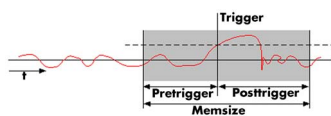

The ring buffer mode is the standard mode of all oscilloscope instruments. Digitized data is continuously written into a ring memory until a trigger event is detected. After the trigger, post-trigger samples are recorded and pre-trigger samples can also be stored. The number of pre-trigger samples available simply equals the total ring memory size minus the number of post trigger samples.

FIFO mode

The FIFO mode is designed for continuous data transfer between measurement board and PC memory (up to 245 MB/s on a PCI-X slot, up to 125 MB/s on a PCI slot and up to 160 MB/s on a PCIe slot) or hard disk. The control of the data stream is done automatically by the driver on interrupt request. The complete installed on-board memory is used for buffer data, making the continuous streaming extremely reliable.

Channel trigger

The digitizers offer a wide variety of trigger modes. These include a standard triggering mode based on a signals level and slope, like that found in most oscilloscopes. It is also possible to define a window mode, with two trigger levels, that enables triggering when signals enter or exit the window. Each input has its own trigger circuit which can be used to setup conditional triggers based on logical AND/OR patterns. All trigger modes can be combined with a re-arming mode for accurate trigger recognition even on noisy signals.

External trigger input

All boards can be triggered using an external analog or digital signal. It's possible to use positive or negative edge. As two analog comparators are used, one can also define a window trigger, a hysteresis trigger or a re-arm trigger.

Universal Multi-Purpose I/Os



All M3i cards offer two universal multi-purpose I/O lines, which can be separately programmed as either input or output. These lines can be used as additional TTL trigger inputs for more complex trigger conditions. When used as outputs, these lines can be used to output card status signals like trigger-armed or to output the trigger to synchronize external equipment.

Multiple Recording

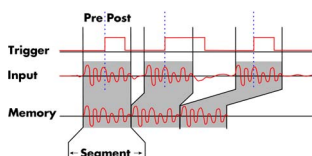

The Multiple Recording mode allows the recording of several trigger events with an extremely short re-arming time. The hardware doesn't need to be restarted in between. The on-board memory is divided in several segments of the same size. Each of them is filled with data if a trigger event occurs. Pre- and posttrigger of the segments can be programmed. The number of acquired segments is only limited by the used memory and is unlimited when using FIFO mode.

The Multiple Recording mode allows the recording of several trigger events with an extremely short re-arming time. The hardware doesn't need to be restarted in between. The on-board memory is divided in several segments of the same size. Each of them is filled with data if a trigger event occurs. Pre- and posttrigger of the segments can be programmed. The number of acquired segments is only limited by the used memory and is unlimited when using FIFO mode.

ABA mode

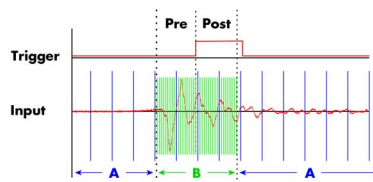

The ABA mode combines slow continuous data recording with fast acquisition on trigger events. The ABA mode works like a slow data logger combined with a fast digitizer. The exact position of the trigger events is stored as timestamps in an extra memory.

Timestamp

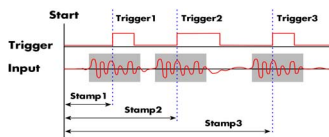

The timestamp function writes the time positions of the trigger events in an extra memory. The timestamps are relative to the start of recording, a defined zero time, externally synchronized to a radio clock, an IRIG-B or a GPS receiver. Using the external synchronization gives a precise time relation for acquisitions of systems on different locations.

External clock input and output

Using a dedicated connector a sampling clock can be fed in from an external system. Additionally it's also possible to output the internally used sampling clock on a separate connector to synchronize external equipment to this clock.

Reference clock

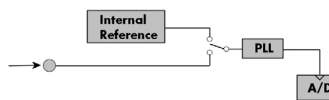

The option to use a precise external reference clock (normally 10 MHz) is necessary to synchronize the instrument for high-quality measurements with external equipment (like a signal source). It's also possible to enhance the quality of the sampling clock in this way. The driver automatically generates the requested sampling clock from the fed in reference clock.

Star-Hub



The star-hub is an additional module allowing the phase stable synchronisation of up to 8 boards of a kind in one system. Independent of the number of boards there is no phase delay between all channels. The star-hub distributes trigger and clock information between all boards. As a result all connected boards are running with the same clock and the same trigger. All trigger sources can be combined with a logical OR allowing all channels of all cards to be trigger source at the same time.

BaseXIO (Asynchronous I/O, enhanced timestamps)



The BaseXIO option offers 8 asynchronous digital I/O lines on the base card, which are available on a separate bracket as SMB connectors. The direction can be selected by software in groups of four. This allows e.g. external equipment control or status monitoring. In addition one of the I/O lines can be used as reference clock for the Timestamp counter.

External Amplifiers



For the acquisition of extremely small voltage levels with a high bandwidth a series of external amplifiers is available. Each of the one channel amplifiers is working with a fixed input impedance and allows - depending on the bandwidth - to select different amplification levels between x10 (20 dB) up to x1000 (60 dB). Using the external amplifiers of the SPA series voltage levels in the μV and mV area can be acquired.

Technical Data

Analog Inputs

Resolution		16 bit	
Input Type		Single-ended	
Programmable Input Offset		not available	
ADC Differential non linearity (DNL)	ADC only	≤ 1.0 LSB	
ADC Integral non linearity (INL)	ADC only	≤ 4.0 LSB	
Channel selection	software programmable	1 or 2 channels (maximum is model dependent)	
Bandwidth filter 4830, 4831	activate by software	10 MHz bandwidth with 3rd order Butterworth filtering	
Bandwidth filter 4840, 4841, 4860, 4861	activate by software	20 MHz bandwidth with 3rd order Butterworth filtering	
Input Path Types	software programmable	50 Ω (HF) Path	Buffered (high impedance) Path
Analog Input impedance	software programmable	50 Ω	1 M Ω 25 pF or 50 Ω
Input Ranges	software programmable	± 500 mV, ± 1 V, ± 2.5 V, ± 5 V	± 200 mV, ± 500 mV, ± 1 V, ± 2 V, ± 5 V, ± 10 V
Input Coupling	software programmable	AC/DC	AC/DC
Offset error (full speed)	after warm-up and calibration	$\leq 0.1\%$	$\leq 0.1\%$
Gain error (full speed)	after warm-up and calibration	$\leq 1.0\%$	$\leq 0.1\%$
Over voltage protection	range $\leq \pm 1$ V	2 Vrms	± 5 V (1 M Ω), 5 Vrms (50 Ω)
Over voltage protection	range $\geq \pm 2$ V	6 Vrms	± 30 V (1 M Ω), 5 Vrms (50 Ω)
Max DC voltage if AC coupling active		± 30 V	± 30 V
Relative input stage delay		0 ns	3.8 ns
Crosstalk 1 MHz sine signal	input range ± 1 V	not available	≤ -100 dB
Crosstalk 20 MHz sine signal	input range ± 1 V	not available	≤ -100 dB
Crosstalk 1 MHz sine signal	input range ± 5 V	≤ -110 dB	≤ -92 dB
Crosstalk 20 MHz sine signal	input range ± 5 V	≤ -102 dB	≤ -92 dB

Trigger

Available trigger modes	software programmable	Channel Trigger, Ext0 (Analog), Ext1 (TT), Software, Window, Re-Arm, Or/And, Delay
Trigger level resolution	software programmable	10 bits
Trigger edge	software programmable	Rising edge, falling edge or both edges
Trigger delay	software programmable	0 to (8GSamples - 8) = 8589934584 Samples in steps of 8 samples
Multi, Gate: re-arming time		≤ 32 samples (+ programmed pretrigger)
Pretrigger at Multi, ABA, Gate, FIFO	software programmable	8 up to [8192 Samples / number of active channels] in steps of 8
Posttrigger	software programmable	8 up to 4 GSamples in steps of 8 (defining pretrigger in standard scope mode)
Memory depth	software programmable	16 up to [installed memory / number of active channels] samples in steps of 8
Multiple Recording/ABA segment size	software programmable	16 up to [installed memory / 2 / active channels] samples in steps of 16
Trigger output delay	after trigger input	134 sampling clock cycles
Internal/External trigger accuracy		1 sample
External trigger		Ext0 (Trg)
External trigger impedance	software programmable	50 Ω / 1 M Ω 25 pF
External trigger coupling	software programmable	AC or DC
Minimum trigger pulse width	(DC / AC)	≥ 2 samples
External trigger bandwidth DC	50 Ω / 1 M Ω	DC to 200 MHz / 150 MHz
External trigger bandwidth AC	50 Ω	20 kHz to 200 MHz
External trigger type		Window comparator, ± 5 V
External trigger level	software programmable	2 levels ± 5 V in steps of 1 mV
External trigger maximum voltage		5V rms (50 Ω), ± 30 V (1 M Ω)
External trigger output impedance		input only
External trigger output levels		input only
External trigger output type		input only
External trigger output drive strength		input only
		Ext1 (X0) + Ext2 (X1)
		10 k Ω to 3.3 V
		fixed DC
		≥ 2 samples
		DC to 125 MHz
		n.a.
		TTL level
		fixed: Low: ≤ 0.8 V, High: ≥ 2.0 V
		-0.3 V to +5.5V
		50 Ω
		Low: ≤ 0.4 V, High: ≥ 2.4 V
		3.3 V LVTTTL compatible for high impedance
		Capable of driving 50 Ω loads, ± 64 mA output

Clock

Clock Modes	software programmable	internal, external reference clock, sync
Internal clock accuracy		$\leq \pm 32$ ppm
Internal clock setup granularity		1 Hz (except the clock setup gaps shown below)
Clock setup range gaps	clock not programmable	70 MHz to 72 MHz, 140 MHz to 144 MHz, 281 MHz to 287 MHz
External reference clock range	software programmable	≥ 10 MHz and ≤ 1 GHz (fix at runtime)
External reference clock setup granularity		1 kHz
External clock input impedance	software programmable	50 Ω fixed
External clock input coupling		AC coupling
External clock input edge		Rising edge
External clock input to internal ADC clock delay		3.7 ns (8.2 ns if synchronization is used)
External clock input type		Single-ended, sine wave or square wave
External clock input swing		0.3 V peak-peak up to 3.0 V peak-peak
External clock input max DC voltage		± 30 V (with max 3.0 V difference between low and high level)
External clock input duty cycle requirement		40% to 60%
External clock output type		Single-ended, 3.3V LVPECL
External clock output coupling		AC coupling
ABA mode clock divider for slow clock	software programmable	8 up to [128k - 8] in steps of 8

	M3i.4830	M3i.4831	M3i.4840	M3i.4841	M3i.4860	M3i.4861
min sampling clock	9 MS/s	9 MS/s	9 MS/s	9 MS/s	9 MS/s	9 MS/s
max internal clock (1 channel active)	65 MS/s	65 MS/s	105 MS/s	105 MS/s	180 MS/s	180 MS/s
max internal clock (2 channels active)	n.a.	65 MS/s	n.a.	105 MS/s	n.a.	180 MS/s
lower bandwidth limit (DC coupling)	0 Hz	0 Hz	0 Hz	0 Hz	0 Hz	0 Hz
lower bandwidth limit (AC coupled, 50 Ohm)	<30 kHz	<30 kHz	<30 kHz	<30 kHz	<30 kHz	<30 kHz
lower bandwidth limit (AC coupled, 1 MOhm)	<2 Hz	<2 Hz	<2 Hz	<2 Hz	<2 Hz	<2 Hz
-3 dB bandwidth (buffered path)	30 MHz	30 MHz	45 MHz	45 MHz	70 MHz	70 MHz
-3 dB bandwidth (50 ohm path)	35 MHz	35 MHz	50 MHz	50 MHz	90 MHz	90 MHz
-3 dB bandwidth (BW limit enabled)	10 MHz	10 MHz	20 MHz	20 MHz	20 MHz	20 MHz

Multi Purpose I/O lines (front-plate)

Number of multi purpose lines		two, named X0, X1
Input: available signal types	software programmable	Trigger-In, Asynchronous Digital-In, Synchronous Digital-In, Timestamp Reference Clock
Input: impedance		10 kΩ to 3.3 V
Input: maximum voltage level		-0.3 V to +5.5V
Input: signal levels		Low: ≤0.8 V, High: ≥2.0 V
Output: available signal types	software programmable	Asynchronous Digital-Out, Trigger Output, Run, Arm
Output: impedance		50 Ω
Output: signal levels		Low: ≤0.4 V, High: ≥2.4 V
Output: type		3.3 V LVTTTL, TTL compatible for high impedance loads
Output: drive strength		Capable of driving 50 Ω loads, maximum strength ±64 mA

BaseXIO Option

BaseXIO modes	software programmable	Asynch digital I/O, 2 additional trigger, timestamp reference clock, timestamp digital inputs
BaseXIO direction	software programmable	Each 4 lines can be programmed in direction
BaseXIO input		TTL compatible: Low ≤ 0.8 V, High ≥ 2.0 V
BaseXIO input impedance		4.7 kOhm towards 3.3 V
BaseXIO input maximum voltage		-0.5 V up to +5.5 V
BaseXIO output type		3.3 V LVTTTL
BaseXIO output levels		TTL compatible: Low ≤ 0.4 V, High ≥ 2.4 V
BaseXIO output drive strength		32 mA maximum current, no 50 Ω loads

Connectors (Standard Card)

Analog Inputs		3 mm SMB male (one for each single-ended input)	Cable-Type: Cab-3f-xx-xx
Trigger ExtIO Input		1 x MMCX female (one connector)	Cable-Type: Cab-1m-xx-xx
Clock Input/Output		2 x MMCX female (two connectors)	Cable-Type: Cab-1m-xx-xx
Multi Purpose X0 and X1		2 x MMCX female (two connectors)	Cable-Type: Cab-1m-xx-xx
Option BaseXIO		8 x 3 mm SMB male on extra bracket, internally 8 x MMCX female	

Connectors (Option M3i.xxxx-SMA)

Analog Inputs		SMA female (one for each single-ended input)	Cable-Type: Cab-3mA-xx-xx
Trigger, Clock I/O, Multi Purpose X0	signals specified at order time	2 x SMA female (two connectors)	Cable-Type: Cab-3mA-xx-xx
Option BaseXIO		8 x 3 mm SMB male on extra bracket, internally 8 x MMCX female	

Connectors (Option M3i.xxxx-SMAM)

Analog Inputs		SMA female (one for each single-ended input)	Cable-Type: Cab-3mA-xx-xx
Trigger ExtIO Input		1 x MMCX female (one connector)	Cable-Type: Cab-1m-xx-xx
Clock Input/Output		2 x MMCX female (two connectors)	Cable-Type: Cab-1m-xx-xx
Multi Purpose X0 and X1		2 x MMCX female (two connectors)	Cable-Type: Cab-1m-xx-xx
Option BaseXIO		8 x 3 mm SMB male on extra bracket, internally 8 x MMCX female	

Environmental and Physical Details

Dimension (PCB only)		312 mm x 107 mm (full PCI length)
Width (Standard or star-hub 4)		1 full size slot
Width (star-hub 8)		additionally back of adjacent neighbour slots
Width (with option BaseXIO)		additionally extra bracket on neighbour slot
Weight	plain card	320 g
Weight	plain card + option SH4	380g
Weight	plain card + option SH8	400g
Warm up time		10 minutes
Operating temperature		0°C to 50°C
Storage temperature		-10°C to 70°C
Humidity		10% to 90%

PCI/PCI-X specific details

PCI / PCI-X bus slot type
 PCI / PCI-X bus slot compatibility
 Sustained streaming mode

32 bit 33 MHz or 32 bit 66 MHz
 32/64 bit, 33-133 MHz, 3,3 V and 5 V I/O
 > 245 MB/s (in a PCI-X slot clocked at 66 MHz or higher)

PCI Express specific details

PCIe slot type
 PCIe slot compatibility
 Sustained streaming mode

x1 Generation 1
 x1/x4/x8/x16 (Some x16 PCIe slots are for graphic cards only and can not be used)
 > 160 MB/s

Certification, Compliance, Warranty

EMC Immunity
 EMC Emission
 Product warranty
 Software and firmware updates

Compliant with CE Mark
 Compliant with CE Mark
 5 years starting with the day of delivery
 Life-time, free of charge

Power Consumption

	PCI / PCI-X			PCI EXPRESS		
	3.3 V	5 V	Total	3.3V	12V	Total
M3i.48x1 (256 MS memory)	1.9 A	2.6 A	19.3 W	0.4 A	1.9 A	24.1 W
M3i.48x1 (2 GSamples memory), max power	3.0 A	2.6 A	22.9 W	0.4 A	2.5 A	31.3 W

MTBF

MTBF 200000 hours

Dynamic Parameters

Input Path	M3i.4861 and M3i.4860, 1 or 2 channels 180 MS/s									
	HF path, AC coupled, fixed 50 Ohm				Buffered path, BW limit			Buffered path, full BW		
	1 MHz	10 MHz	40 MHz		10 MHz			1 MHz	10 MHz	40 MHz
Test signal frequency										
Input Range	±1V	±500mV	±1V	±1V	±200mV	±500mV	±1V	±500mV	±500mV	±500mV
RMS Noise (zero level)	≤ 8.0 LSB				≤ 10.0 LSB			≤ 10.0 LSB		
THD (typ) (dB)	-80.6	-79.2	-79.3	-77.8	-77.4	-77.7	-75.3	-83.4	-77.7	-47.8
SNR (typ) (dB)	73.1	73.3	73.4	71.9	71.4	72.8	73.1	71.1	72.8	68.6
SFDR (typ), excl. harm. (dB)	92.4	96.0	96.8	87.8	95.8	96.8	96.7	87.6	96.4	88.2
SFDR (typ), incl. harm. (dB)	81.1	80.5	80.5	78.8	79.0	78.7	76.2	85.2	79.0	48.0
SINAD/THD+N (typ) (dB)	72.4	72.3	72.3	70.9	70.4	71.6	73.1	70.9	71.6	47.8
ENOB based on SINAD (bit)	11.7	11.7	11.7	11.5	11.4	11.6	11.5	11.5	11.6	7.6
ENOB based on SNR (bit)	11.9	11.9	11.9	11.7	11.6	11.8	11.8	11.5	11.8	11.1

Input Path	M3i.4841 and M3i.4840, 1 or 2 channels 105 MS/s								
	HF path, AC coupled, fixed 50 Ohm				Buffered path, BW limit			Buffered path, full BW	
	1 MHz	10 MHz			10 MHz			1 MHz	10 MHz
Test signal frequency									
Input Range	±1V	±500mV	±1V		±200mV	±500mV	±1V	±500mV	±500mV
RMS Noise (zero level)	≤ 7.0 LSB				≤ 10.0 LSB			≤ 10.0 LSB	
THD (typ) (dB)	-86.0	-87.3	-88.0		-83.0	-82.1	-76.2	-85.0	-79.8
SNR (typ) (dB)	74.5	74.7	74.7		71.7	73.9	74.2	73.1	73.0
SFDR (typ), excl. harm. (dB)	93.0	97.0	97.1		92.8	93.5	93.1	92.5	96.3
SFDR (typ), incl. harm. (dB)	86.5	91.5	91.7		85.3	85.1	79.0	87.5	81.5
SINAD/THD+N (typ) (dB)	74.2	74.5	74.5		71.4	73.3	72.1	72.8	72.2
ENOB based on SINAD (bit)	12.0	12.1	12.1		11.6	11.9	11.7	11.8	11.7
ENOB based on SNR (bit)	12.1	12.1	12.1		11.6	12.0	12.0	11.9	11.8

Input Path	M3i.4831 and M3i.4830, 1 or 2 channels 65 MS/s								
	HF path, AC coupled, fixed 50 Ohm				Buffered path, BW limit			Buffered path, full BW	
	1 MHz	10 MHz			10 MHz			1 MHz	10 MHz
Test signal frequency									
Input Range	±1V	±500mV	±1V		±200mV	±500mV	±1V	±500mV	±500mV
RMS Noise (zero level)	≤ 5.0 LSB				≤ 9.0 LSB			≤ 9.0 LSB	
THD (typ) (dB)	-85.0	-86.2	-86.2		-83.5	-80.8	-76.5	-84.1	-80.4
SNR (typ) (dB)	75.0	75.4	75.2		72.3	74.6	74.8	73.8	74.2
SFDR (typ), excl. harm. (dB)	94.5	92.0	90.8		88.5	91.4	90.7	88.3	91.0
SFDR (typ), incl. harm. (dB)	81.5	87.7	87.5		84.7	83.3	78.8	85.2	81.5
SINAD/THD+N (typ) (dB)	74.6	75.1	74.9		72.0	73.7	72.6	73.4	73.4
ENOB based on SINAD (bit)	12.0	12.2	12.2		11.7	11.9	11.8	11.9	11.9
ENOB based on SNR (bit)	12.2	12.2	12.2		11.7	12.1	12.1	12.0	12.0

A pure sine wave with > 99% amplitude of input range is measured with 50 ohms termination. SNR and RMS noise parameters may differ depending on the quality of the used PC. SNR = Signal to Noise Ratio, THD = Total Harmonic Distortion, SFDR = Spurious Free Dynamic Range, SINAD = Signal Noise and Distortion, ENOB = Effective Number of Bits. Depending on the test signal frequency different filter types are used: 1 MHz signal = 7th order low pass, 10 MHz signal = 6th order band pass, 40 MHz signal = 6th order bandpass.

Hardware block diagram

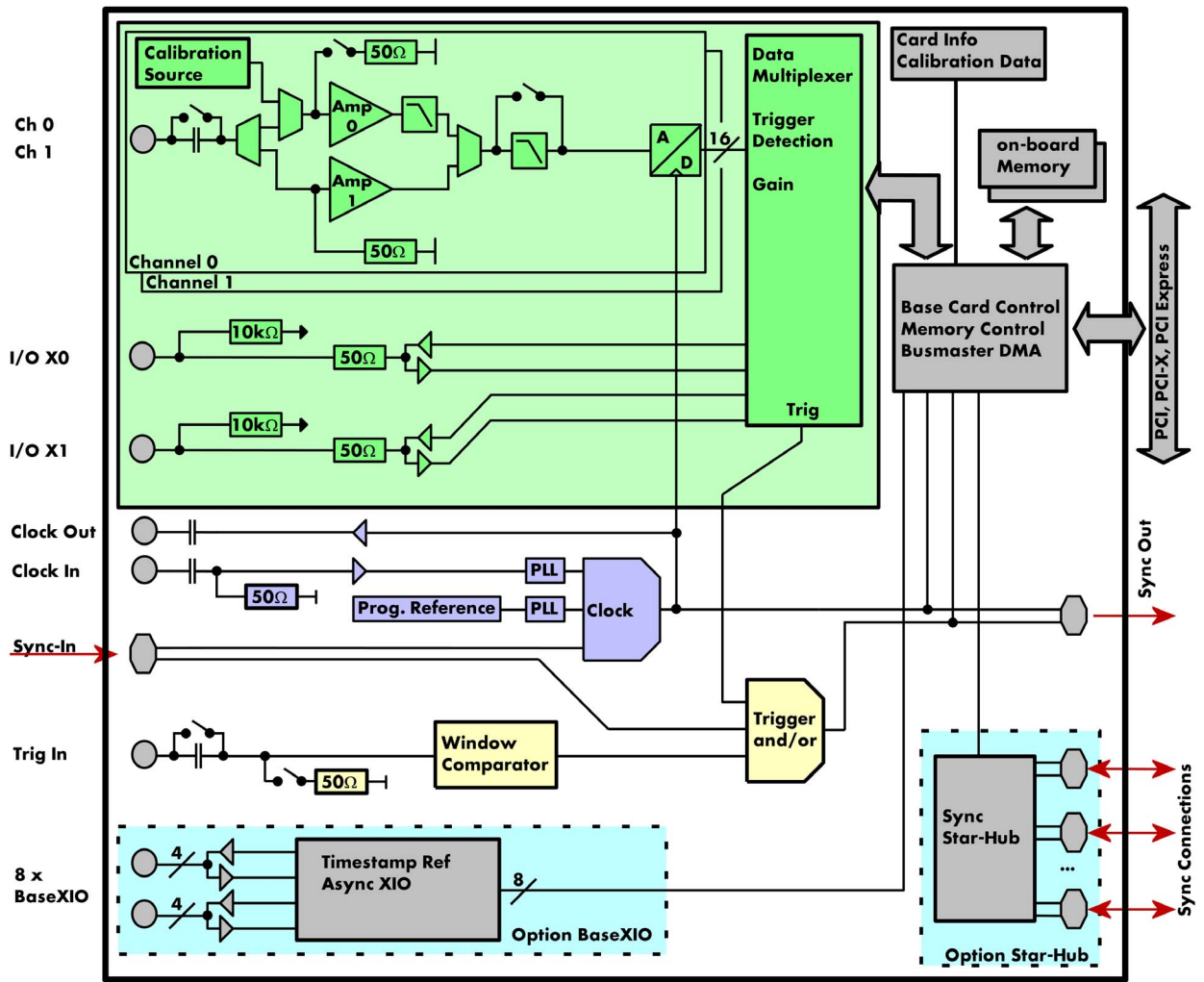

Order Information

The card is delivered with 256 MSample on-board memory and supports standard acquisition (Scope), FIFO acquisition (streaming), Multiple Recording, ABA mode and Timestamps. Operating system drivers for Windows/Linux 32 bit and 64 bit, examples for C/C++, LabVIEW (Windows), MATLAB (Windows and Linux), LabWindows/CVI, IVI, .NET, Delphi, Visual Basic, Java, Python and a Base license of the oscilloscope software SBench 6 are included. Drivers for other 3rd party products like VEE or DASYLab may be available on request.

Adapter cables are not included. Please order separately!

PCI/PCI-X

PCI Express

PCI Express	PCI/PCI-X	Standard mem	1 channel	2 channels
M3i.4830-exp	M3i.4830	256 MSample	65 MS/s	
M3i.4831-exp	M3i.4831	256 MSample	65 MS/s	65 MS/s
M3i.4840-exp	M3i.4840	256 MSample	105 MS/s	
M3i.4841-exp	M3i.4841	256 MSample	105 MS/s	105 MS/s
M3i.4860-exp	M3i.4860	256 MSample	180 MS/s	
M3i.4861-exp	M3i.4861	256 MSample	180 MS/s	180 MS/s

Memory

Order no.	Option
M3i.xxxx-512MS	Memory upgrade to 512 MSample (1 GB) total memory
M3i.xxxx-1GS	Memory upgrade to 1 GSsample (2 GB) total memory

Options

Order no.	Option
M3i.xxxx-SH4	Synchronization Star-Hub for up to 4 cards, only 1 slot width
M3i.xxxx-SH8	Synchronization Star-Hub for up to 8 cards, 2 slots width
M3i.xxxx-bxio	Option BaseXIO: 8 digital I/O lines usable as asynchronous I/O and timestamp ref-clock, additional bracket with 8 SMB connectors
M3i.xxxx-SMA	Option SMA connections for all analog inputs + two control signals (fixed at order time): - SMA connection XA: Trigger-In or Trigger-Out/Multi Purpose X0 - SMA connection XB: Trigger-In or Clock In or Clock-Out
M3i.xxxx-SMAM	Option SMA connections for all analog inputs + MMCX connections for all control signals (clock I/O, trigger I/O, multipurpose X0, X1)
M3i-upgrade	Upgrade for M3i.xxxx: later installation of option -M3i.xxxx-1GS, -bxio, -SH4, SH8 or SMA connectors

Services

Order no.	
Recal	Recalibration at Spectrum incl. calibration protocol

Standard Cables

for Connections	Length	Order no.				
		to BNC male	to BNC female	to SMA male	to SMA female	to SMB female
Standard inputs	80 cm	Cab-3f-9m-80	Cab-3f-9f-80	Cab-3f-3mA-80	Cab-3f-3fA-80	
Standard inputs	200 cm	Cab-3f-9m-200	Cab-3f-9f-200	Cab-3f-3mA-200	Cab-3f-3fA-200	
Probes (short)	5 cm		Cab-3f-9f-5			
Trigger/Clock/Extra	80 cm	Cab-1m-9m-80	Cab-1m-9f-80	Cab-1m-3mA-80	Cab-1m-3fA-80	Cab-1m-3f-80
Trigger/Clock/Extra	200 cm	Cab-1m-9m-200	Cab-1m-9f200	Cab-1m-3mA-200	Cab-1m-3fA-200	Cab-1m-3f-200
SMA Option	80 cm	Cab-3mA-9m-80	Cab-3mA-9f-80			
SMA Option	200 cm	Cab-3mA-9m-200	Cab-3mA-9f-200			
Information	The standard adapter cables are based on RG174 cables and have a nominal attenuation of 0.3 dB/m at 100 MHz and 0.5 dB/m at 250 MHz. For high speed signals we recommend the low loss cables series CHF together with the SMA connector option M3i.xxxx-SMA oder M3i.xxxx-SMAM.					

Low Loss Cables

Order no.s	Option
CHF-3mA-3mA-200	Low loss cables SMA male to SMA male 200 cm
CHF-3mA-9m-200	Low loss cables SMA male to BNC male 200 cm
Information	The low loss adapter cables are based on MF141 cables and have an attenuation of 0.3 dB/m at 500 MHz and 0.5 dB/m at 1.5 GHz. They are recommended for signal frequencies of 200 MHz and above. Card SMA connectors are needed. Make sure to order one of the options M3i.xxxx-SMA or M3i.xxxx-SMAM together with the card.

Amplifiers

Order no.	Bandwidth	Connection	Input Impedance	Coupling	Amplification
SPA.1841 ⁽²⁾	2 GHz	SMA	50 Ohm	AC	x100 (40 dB)
SPA.1801 ⁽²⁾	2 GHz	SMA	50 Ohm	AC	x10 (20 dB)
SPA.1601 ⁽²⁾	500 MHz	BNC	50 Ohm	DC	x10 (20 dB)
SPA.1412 ⁽²⁾	200 MHz	BNC	1 MOhm	AC/DC	x10/x100 (20/40 dB)
SPA.1411 ⁽²⁾	200 MHz	BNC	50 Ohm	AC/DC	x10/x100 (20/40 dB)
SPA.1232 ⁽²⁾	10 MHz	BNC	1 MOhm	AC/DC	x100/x1000 (40/60 dB)
SPA.1231 ⁽²⁾	10 MHz	BNC	50 Ohm	AC/DC	x100/x1000 (40/60 dB)
Information	External Amplifiers with one channel, BNC/SMA female connections on input and output, manually adjustable offset, manually switchable settings. An external power supply for 100 to 240 VAC is included. Please be sure to order an adapter cable matching the amplifier connector type and matching the connector type for your A/D card input.				

Software SBench6

Order no.	
SBench6	Base version included in delivery. Supports standard mode for one card.
SBench6-Pro	Professional version for one card: FIFO mode, export/import, calculation functions
SBench6-Multi	Option multiple cards: Needs SBench6-Pro. Handles multiple synchronized cards in one system.
Volume Licenses	Please ask Spectrum for details.

Software Options

Order no.	
SpcRServer	Remote Server Software Package - LAN remote access for M2i/M3i/M4i/M4x/M2p cards

⁽¹⁾ : Just one of the options can be installed on a card at a time.

⁽²⁾ : Third party product with warranty differing from our export conditions. No volume rebate possible.

Technical changes and printing errors possible

SBench, digitizerNETBOX and generatorNETBOX are registered trademarks of Spectrum Instrumentation GmbH. Microsoft, Visual C++, Visual Basic, Windows, Windows 98, Windows NT, Window 2000, Windows XP, Windows Vista, Windows 7, Windows 8 and Windows 10 are trademarks/registered trademarks of Microsoft Corporation. LabVIEW, DASLab, Diadem and LabWindows/CVI are trademarks/registered trademarks of National Instruments Corporation. MATLAB is a trademark/registered trademark of The Mathworks, Inc. Keysight VEE, VEE Pro and VEE OneLab are trademarks/registered trademarks of Keysight Technologies, Inc. FlexPro is a registered trademark of Weisang GmbH & Co. KG. PCIe, PCI Express and PCI-X and PCI-SIG are trademarks of PCI-SIG. LXI is a registered trademark of the LXI Consortium. PICMG and CompactPCI are trademarks of the PCI Industrial Computer Manufacturers Group. Oracle and Java are registered trademarks of Oracle and/or its affiliates. Intel and Intel Xeon are trademarks or registered trademarks of Intel Corporation. AMD and Opteron are trademarks or registered trademarks of Advanced Micro Devices.